

## SEMI-AUTOMATIC TUBE FILTER SYSTEM FOR DRY, POWDERY BULK MATERIALS



**Dedusting filter with  
mechanical dedusting**

The filter is used for discontinuous load and convey processes with powdery dry bulk materials.

**Areas of application**

- Mechanically cleaned tube filter with an out-of-balance shaker.
- Easy maintenance due to 3-door body design and easy to open weather hood.
- Doors with self-closing and adjustable spring lock.
- Equipped with 24 filter tubes made of polyester / polyester needle felt and maintenance friendly clip-in locks including sealing material and fixing screws.
  
- Steel frame, outside parts are hot-dip galvanised

**Details / Explanation**

**Finish**

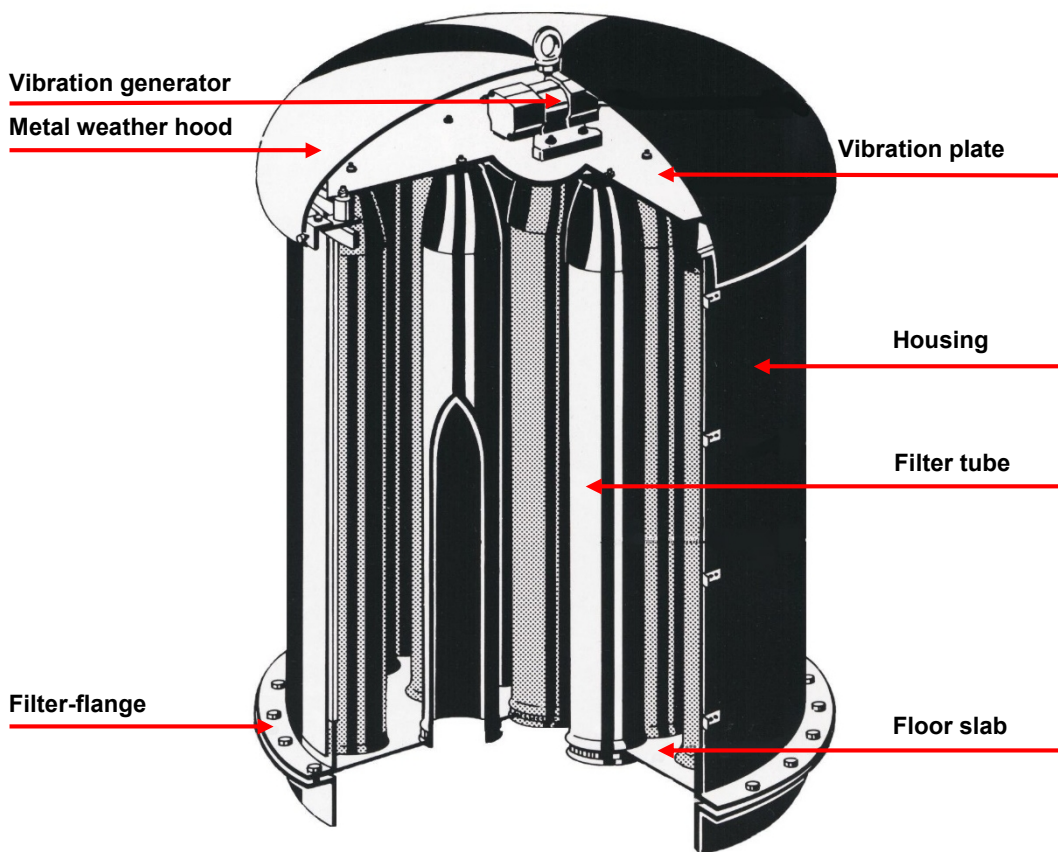

Maintenance friendly design

Without loose or accident-sensitive parts

**SCHEME OF STREAMING**

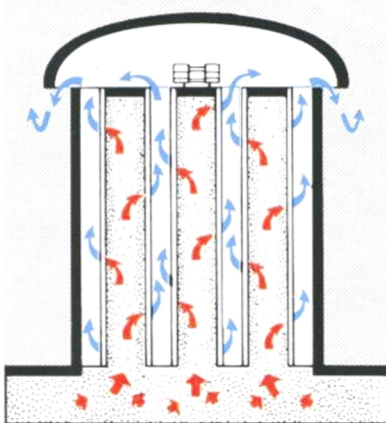

**1.** Raw gas flows in the filter tubes which are open at the bottom and locked on top. In the process pure gas escapes through the filter cladding and weather hood.

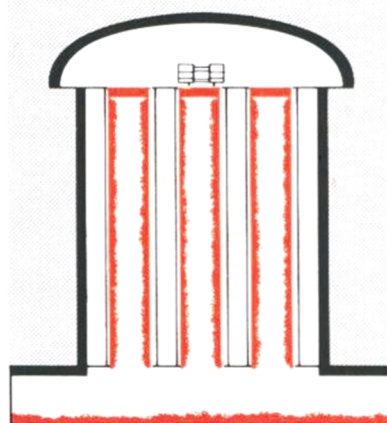

**2.** After the loading process is finished, the filter tube unit is coated with dust on the inside.

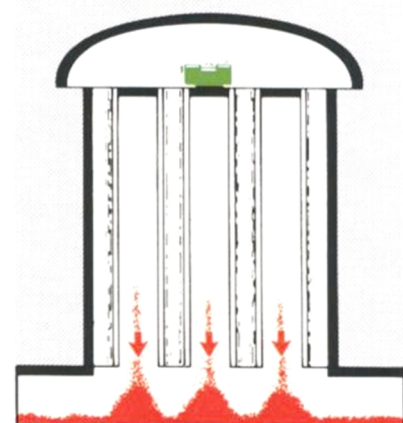

**3.** Through manual or automatic activation the vibrator starts to oscillate and cleans the tube area. The material flows back into the silo.

**Dimensions Stafi**

Model	17	20
Outside $\varnothing$ mm	1200	
Inside $\varnothing$ mm	1100	
Hole circle mm	1150	
Number of holes/ $\varnothing$ mm	12 x $\varnothing$ 13	
Height mm	1700	1900
Filter edge $\varnothing$ mm	1100	

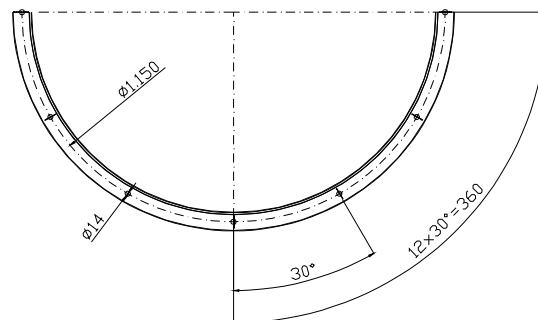
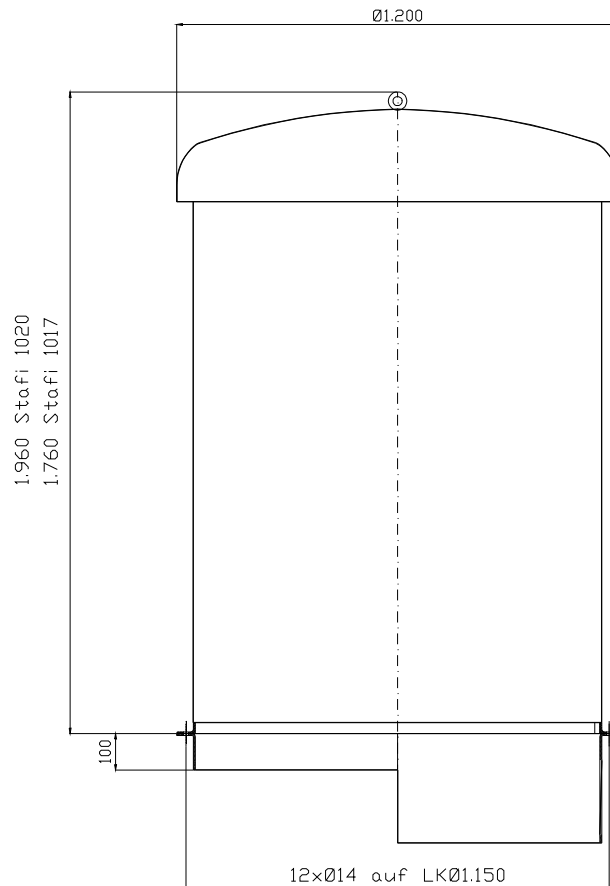

**Technical data Stafi**

Model	17	20
Capacity Nm <sup>3</sup> /h	800	1000
Maximum temperature	80° C	
Number of filter tubes	24	
Filter medium	Polyester / polyester needle felt	
Weight	146 kg	149 kg
Voltage	400 V / 50 Hz	
Engine Power	0,16 KW	

**Article Number**

Model	17	20
	Article number	Article number
Design in steel	721 10 196	721 10 198
Design in stainless steel	721 10 092	721 10 094
Antistatic filter tubes + stainless steel bottom plate (1.4301)	721 10 200	721 10 201

**Extra Charges For**

Transport Design	Article number
Filter is designed for lying transportation, with boosted filter frame, 3-door body (without easy to open weather hood). Rubber collar to cover the air outlet between weather hood and filter body (avoids the entrance of splash and rain water).	721 10 182

Filter top frame with exhaust air socket	Article number
Filter frame in reinforced design with 3 doors. Filter attachment with exhaust air socket DN 200 (Jacob flange) as well as with sealed weather hood (height increases for about 300 mm).	721 10 116

Bottom plate made of stainless steel (1.4301)	Article number
For Stafi in steel design	721 10 065

**Additional sizes and options can be tailored to your special application!**

**When placing an order please define the materials which are stored in your silo (e.g. cement, lime etc...)**

**Notice!**



Fully automatic filter control	Article number
<p>For fully automatic activation of filter dedusting <b>before</b> and <b>after</b> filling the silo. By actuating a lockable clamp (padlock) a rugged mechanical limit switch is activated. As a result coupling and uncoupling of the loading tube activates the dedusting process through a timer.</p> <p>Timer in plastic housing (IP 54) for installation on the silo or switching box of the overfill protection.</p> <p>Voltage 230/400 V / 50 Hz.</p>	<p>881 10 003</p>



Semi-automatic filter control	Article number
<p>For semi-automatic activation of the filter dedusting by manual activation (pushbutton), consisting of:</p> <p>Pushbutton and timer in the plastic housing (IP 54) for installation on the silo or switching box of the overfill protection.</p> <p>Voltage 230/400 V / 50 Hz.</p>	<p>881 10 025</p>









Equipment / Spare parts

Filter type	Article number	
Filter hose 1014 Polyester, Clipin Set 24 pieces	721 10 133	
Filter hose 1014 Needle felt, Clipin Set 24 pieces	721 10 130	
Filter hose 1014 Needle felt, Clipin Set 24 pieces <b>ATEX</b>	721 10 131	 
Filter hose 1017 Polyester, Clipin Set 24 pieces	721 10 138	
Filter hose 1017 Needle felt, Clipin Set 24 pieces	721 10 135	
Filter hose 1017 Needle felt, Clipin Set 24 pieces <b>ATEX</b>	721 10 136	 
Filter hose 1020 Polyester, Clipin Set 24 pieces	721 10 143	
Filter hose 1020 Needle felt, Clipin Set 24 pieces	721 10 140	
Filter hose 1017 Needle felt, Clipin Set 24 pieces <b>ATEX</b>	721 10 141	 
Tension lock with safety device	721 10 107	
Counter hook for tension lock	721 10 117	

Installed centred on silo roof, nominal diameter 1100 mm, height 100 mm	721 10 006 Made of steel plate, primed	
	721 10 063 Made of stainless steel	
Installed decentred on the silo roof (e.g. separating plate silo) nominal diameter 1100 mm, height 200 mm.	721 10 005 Made of steel plate, primed	
	721 10 064 Made of stainless steel	
Metal weather hood	721 10 110	
Locking screw	721 10 074	
Vibration generator 400 V / AC	882 10 001	
Vibration generator, <b>ATEX</b> , II 2 G/D 	882 10 013	
Vibration plate	721 10 048	
Rubber-bonded metal	721 10 043	
Housing, 3 parts Door for STAFI 1014	721 10 072	
Housing, 3 parts Door for STAFI 1017	721 10 071	
Housing, 3 parts Door for STAFI 1020	721 10 111-01	
Floor slab	721 10 029	

Putty cord	721 10 183	
Gas pressure spring	721 10 073	

**Equipment / Spare parts old version Stafi**

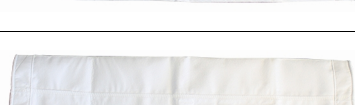
Filter type	Article number	
Tubular tape for old version Stafi 1010 Needle felt, Clipin Set 24 pieces	721 10 124	
Tubular tape for old version Stafi 1010 polyester, Clipin Set 24 pieces	721 10 127	
Tubular tape for old version Stafi 1014 Needle felt, Clipin Set 24 pieces	721 10 129	
Tubular tape for old version Stafi 1014 polyester, Clipin Set 24 pieces	721 10 132	
Tubular tape for old version Stafi 1017 Needle felt, Clipin Set 24 pieces	721 10 134	
Tubular tape for old version Stafi 1017 polyester, Clipin Set 24 pieces	721 10 137	
Tubular tape for old version Stafi 1020 Needle felt, Clipin Set 24 pieces	721 10 139	
Tubular tape for old version Stafi 1020 polyester, Clipin Set 24 pieces	721 10 142	
Tubular tape D 160 for Stafi old version	721 10 019	